

multitek



PowerRelay

The combination transducer relay

POWER RELAY

The M570-PR* PowerRelay is a combination of multifunctional relay and AC power transducer. The RS485 communication port provides Modbus output of all parameters measured and allows programming of the 4 relays as well as programming of CT and VT ratios, demand times etc.

RELAY SETUP

The M570-PR* PowerRelay Setup allows programming of the 4 independent relays and any 8 parameters out of 18 assignable can be assigned to 3 of these relays. Each relay has adjustable parameters, such as set point, time delay etc. The 4th relay is an option and can be used for pulsed output for W.h VAR.h VA.h A.h

Parameters

20 different parameters can be assigned to the relays.

Relay Mode

The relay can be assigned so that it operates as an over, under or window type.

Trip (% Range)

The trip-point (setpoint) can be adjusted between 10 and 120% of nominal input.

Reset (% Range)

The reset (differential) can be adjusted between 1 and 120% of nominal input.

The screenshot shows the 'Relay Setup' window with 8 columns for Parameter 1 through Parameter 8. Each column contains a grid of settings:

- Assignment:** Dropdown menu (e.g., V (Volts), A (Amps), Hz (Frequency), W (Power), VAR (Reactive), -W (Reverse), -VAR (Rev.VAR), Vbal (V Balan)).
- Relay Mode:** Dropdown menu (Over, Under, Window).
- Setpnt (% Range):** Text input field.
- Diff (% Range):** Text input field.
- Group Logic:** Dropdown menu (Average, Any 1, Any 3, Sum).
- Time Delay:** Text input field with a unit 's'.
- Attach To Relay:** Dropdown menu (1, 2, 3).
- Disabled:** Check box.

Below the grid, there are summary statistics for each parameter, such as 'Range 0-230.00V (0-100%)' and 'Setpoint = 253.00V'. At the bottom, there are fields for 'Relay #' (set to 1) and 'Type' (set to Operate), along with 'Help', 'OK', and 'Cancel' buttons.

Group Logic

Allows the relay to trip on 1, 2, 3 phases, the sum or the average of the systems assigned parameter when limits are reached.

Time Delay

The time delay can be set between 40msec to 2 minutes in 1 second steps.

Attach to Relay

The parameter can be attached to relay 1, relay 2 or relay 3.

Relay Action

The relay can be programmed to energise on trip or de-energise on trip.

PULSED OUTPUT RELAY

The fourth relay is an option and is used as an energy relay providing a pulse output corresponding to either Watt hour Import or Export, VAR hour Import or Export, VA hour or Ampere hour. Pulse width can be selected as well as the relay divisor which allows relay to pulse every 1, 10 or 100 counts.

RELAYS STATE

The free set up and monitor software allows monitoring of the state of each relay as well as indicating the parameters assigned. See below the exceptions screen.

Select Parameter

Select either
W.h import or export
VAr import or export
VA.h or A.h

Units

The pulsed output will either be h or k.h or M.h this is automatically set by C.T. and V.T. ratios of the system.

State Reference

Key to relay conditions

Under/Over/Window

Over condition red band.
Under condition green band.
Window condition blue band.

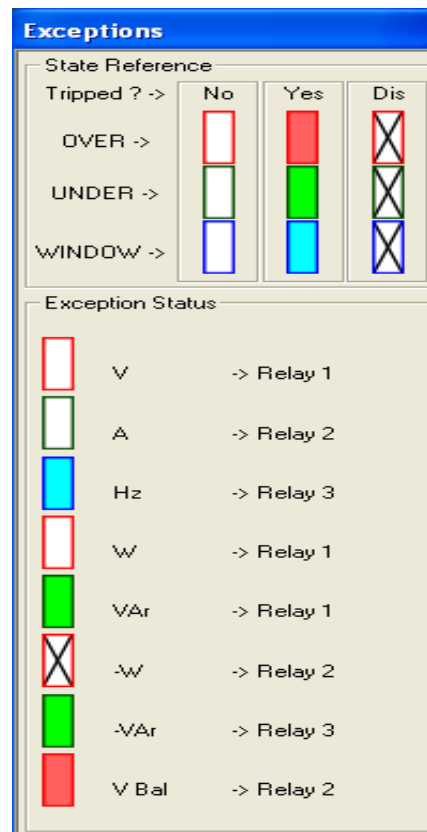
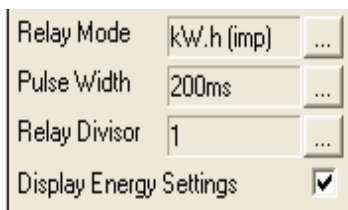
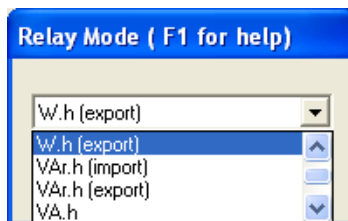

Relay Mode

Assigns the relay to Watt hour import Ampere hour etc. Pulse width sets the width of relay pulse.

Display Energy Settings

Tick this box and the monitor displays the energy relay settings.

Dis

If a parameter is not assigned. The box contains a cross (disconnected).

Exception status

This shows the parameter, the relay that it is assigned to and the state that relay is in. Colour band indicates over, under or window.

SYSTEM MONITOR

The System Monitor program displays all 42 parameters being measured. CT and VT ratios demand times, etc. all can be set via this program. The System Monitor enables programming of the 4 relays as well as data logging. System Monitor is free and contains help files and operating instructions. It can be downloaded from Multitek website: www.multitek-ltd.com

COMMUNICATION

PowerRelay uses RS485 Modbus protocol. This enables remote reading and programming of the PowerRelay via a host computer. The RS485 allows up to 32 PowerRelays to be connected in parallel, allowing them to be used with PC, PLC, RTU, Data loggers and Scada programs. RS485 to USB converters now available.

Type

Displays system type
i.e. 3 phase 4 wire,
3 phase 3 wire
etc.

Voltage Current

Voltage and Current ratios
can be programmed and the
values are displayed.

Monitor / Log

Display 6 parameters at a
time, showing the
instantaneous value.

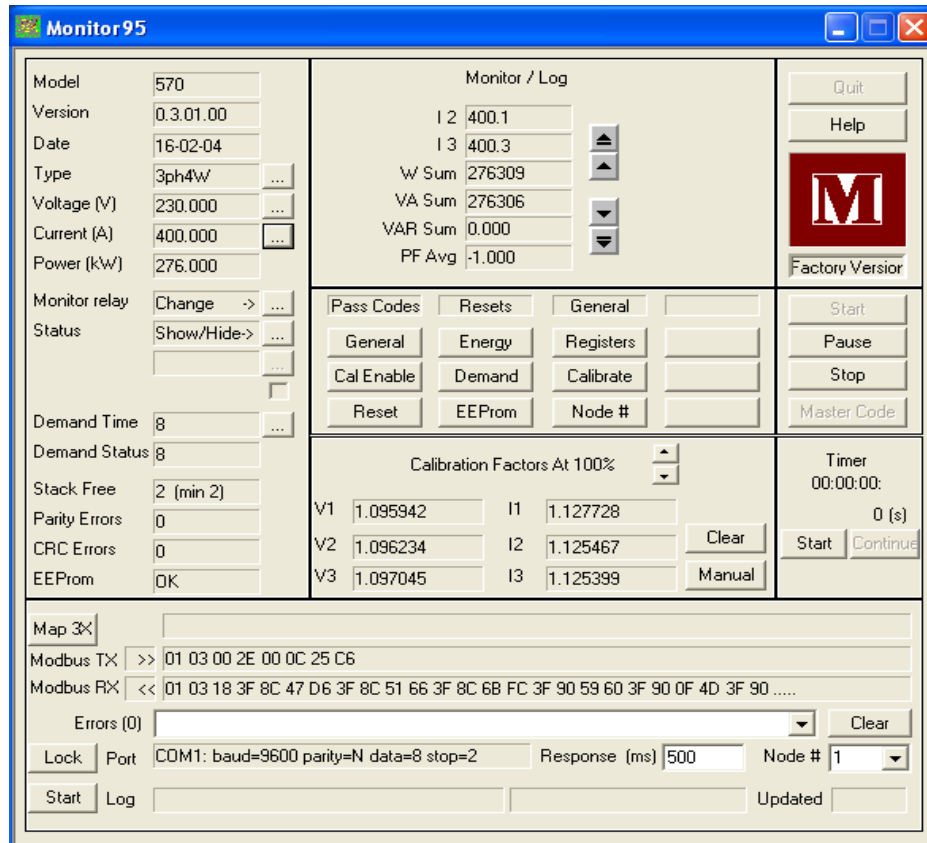

Start Log

User goes into the log screen
and logging of up to 6
parameters can be
performed.

Response Time

User can set response time.

Node

Node (address) can be set
between 1 and 247.

PARAMETERS ASSIGNABLE TO RELAYS **PARAMETERS MEASURED**

- * Phase Voltage (V)
- * Phase Current (I)
- * Phase Balance (V)
- * Frequency (Hz)
- * Reverse Power. (-W)
- * Reverse VAr (-VAr)
- * System Active Power (W)
- * System Reactive Power (VAr)
- * Apparent Power per phase (VA)
- * System Apparent Power (VA)
- * Import Active Energy (W.h)
- * Export Active Energy (W.h)
- * Import Reactive Energy (VAr.h)
- * Export Reactive Energy (VAr.h)
- * Apparent Energy (VA.h)
- * Ampere Energy (A.h)
- * Amp Demand (Ad)
- * Import Watt Demand (Wd)
- * Export Watt Demand (Wd)
- * V A Demand (VAd)

- * Phase Voltage (V)
- * Line Voltage (V)
- * Phase Current (I)
- * Frequency (Hz)
- * Active Power per phase (W)
- * System Active Power (W)
- * Reactive Power per phase (VAr)
- * System Reactive Power (VAr)
- * Apparent Power per phase (VA)
- * System Apparent Power (VA)
- * Import Active Energy (W.h)
- * Export Active Energy (W.h)
- * Import Reactive Energy (VAr.h)
- * Export Reactive Energy (VAr.h)
- * Apparent Energy (VA.h)
- * Ampere Energy (A.h)
- * Power Factor per phase (P.F.)
- * System Power Factor (P.F.)
- * Amp Demand (Ad)
- * Watt Demand (Wd)
- * V A Demand (VAd)
- * Maximum Amp Demand (Max Ad)
- * Maximum Watt Demand Import (Max Wd)
- * Maximum Watt Demand Export (Max Wd)
- * Maximum VA Demand (Max VAd)
- * Neutral Current

SYSTEMS

PRODUCT CODE

Single Phase	M570-PR1
Single Phase 3 wire	M570-PR1-3
3 phase 3 wire unbalanced load	M570-PR4
3 phase 4 wire unbalanced load	M570-PR9

MEMORY

All data including, energy registers, current and voltage ratios relay trip points and calibration data is stored in a non volatile eeprom. Under power down (power loss) conditions this data is retained.

APPLICATIONS

Applications include generating sets, switchgear, management systems, distribution feeders, control panels, UPS systems, process control, generating systems, power management and control.

AUTO-CONFIGURABLE

The PowerRelay communication port is auto-configurable meaning that when connected to an existing Modbus network it will automatically set Baud rate, Parity and Stop bits.
A green LED is provided to indicate power is present, and the unit is communicating correctly.

OUTPUT RELAYS

Relay type: Single Pole A or B contact.

Material: AgSnInO

AC Rating: 250V 5A DC Rating: 30V 1A

Relay's R1 and R2 are normally open

Relay R3 is normally closed.

Note contact operation of R1, R2 and R3 can be changed on request when ordering.

Relay R4 is normally open and closes when unit counts energy etc.

Terminal 19 is common to all 4 relays

RELAY ACCURACY

Specified @ 23°C 10%-Un 10%-In

Voltage & Current:-

Accuracy $\pm 1\%$ of range

Resolution $\pm 1\%$

Frequency:-

Accuracy $\pm 0.02\text{Hz}$

Repeatability $\pm 0.02\text{Hz}$

All other Parameters:-

Accuracy $\pm 2\%$

Repeatability $\pm 1\%$

GENERAL SPECIFICATION

INPUT

Rated Un	Direct connected voltages between 57.8 and 600 V. Specify nominal.
Range	10-120% Un
Overload	1.5 x Un cont. 4 x Un for 1 sec
Rated In	1 or 5 amp
Range	10-120% In
Burden	0.5VA per phase Volts & Amps
Overload	4 x In continuous. 50 x In for 1sec
Frequency	50 / 60 Hz nominal range 45/65Hz

MODBUS ACCURACY

Specified @ 23°C	10%-Un 10%-In
Parameters unless stated	Class 0.3% to IEC 688
Volts and Amps	Class 0.25% to IEC 688
Frequency	Class 0.1Hz to IEC 688
Power Factor	Class 1.0% to IEC 688
Active & Reactive Energy	1% of reading IEC1036

INSULATION

Test Voltage	4 kV RMS 50 Hz for 1 min Inputs/Case/Auxiliary/Output 3kV RS485 / Outputs 1.5kV Relay
Impulse Test	EMC 5kV transient complying with IEC 801 / EN 55020 HF
Surge withstand	IEC 801 / EN55020 ANSI C37.90A
Interference	EHF 2.5 kV 1Mhz complying with IEC 255-4
Protection Class	II complying with IEC348

APPLIED STANDARDS

General	IEC 688 BSEN60688, BS4889, IEC 359
EMC	Emissions EN61326-1 Immunity EN61326-2
Safety	EN61010-1

AUXILIARY

AC voltage	115, 230, 277, 400 volts (±15%)
DC voltage	12, 24, 48, 110, 125, volts (±15%) Specify nominal voltage.

ENVIRONMENTAL

Working Temperature	-25 to +70 deg C
Storage Temperature	-40 to +85 deg C
Temperature Coefficient	0.01% per deg C

APPROVALS

UL, C-UL, CSA

CASE DIMENSIONS

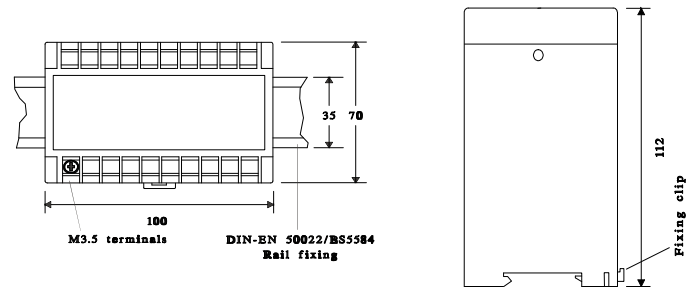

CONNECTION DIAGRAMS

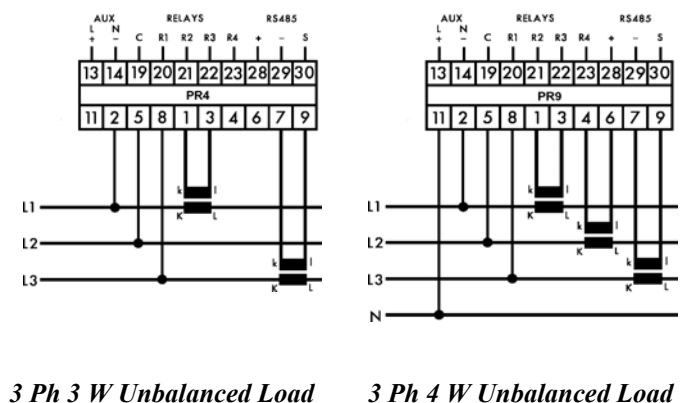
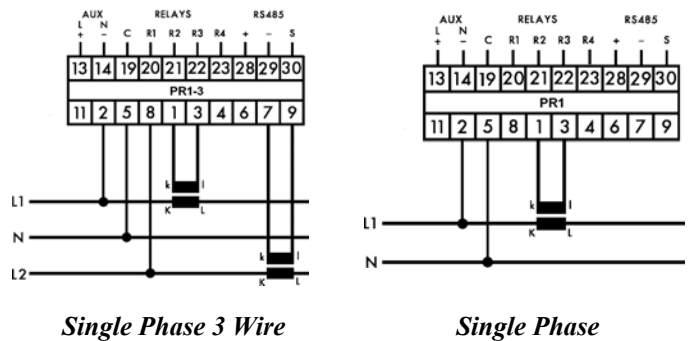

multitek®

Multitek Ltd. Lancaster Way, Earls Colne Business, Park, Earls Colne, Colchester, Essex. CO6 2NS. England. Tel. (01787) 223228 Fax. (01787) 223607
E-MAIL: sales@multitek-ltd.com WEB SITE: www.multitek-ltd.com