

KISTOCK DATALOGGER KT 220 / KH 220 / KTT 220

Temperature / Humidity / Light / Current
Voltage / Impulsion / Water pressure



KEY POINTS

- Available with or without display
- Software for configuration and data visualisation freely downloadable
- Software for configuration and data processing available as option
- Storage capacity of 1 000 000 points
- Fast data downloading (18 000 points/s)
- Up to 5 recordable parameters simultaneously
- 2 configurable setpoint alarms for each channel
- 2 lines LCD screen
- Magnetic mounting

REFERENCES

Device reference	Display	Internal sensor		External sensor		Parameters	Number of record points
		Number	Type	Number	Type		
KT 220 - O	Yes	1	Temperature	1	Input for universal probe*	Temperature, humidity, current, voltage, impulsion, water pressure	1 000 000
KT 220 - N	No						
KH 220 - O	Yes	3	Temperature, Humidity, Light			Temperature, humidity, current, voltage, impulsion, water pressure, light	
KH 220 - N	No						
KTT 220 - O	Yes	-		2	Inputs for thermocouple probes	Temperature	
KTT 220 - N	No						

 For a fast measurement of temperature and humidity variations, it is better to use a remote probe (KTHA or KTHD probe, see page 3).

HOUSING

Dimensions

93.2 x 65.2 x 30.5 mm

Weight

115 g

Display

2 lines LCD screen
(for models with display)
Dimensions of screen: 39 x 34 mm
2 indication LEDs (red and green)

Control

1 OK key
1 Selection key

Material

Compatible with food industry environment
ABS housing

Battery power supply

1 AA lithium 3.6 V battery

Protection

IP 65: KT 220
IP 54: KTT 220**
IP 40: KH 220

PC communication

1 micro-USB input

Environmental conditions of use

Air and neutral gases
Hygrometry: in non condensing condition
Maximum altitude: 2000 m

* Input which allows to plug different compatible probes: see the optional probes and cables page 3.

** With all the thermocouple probes connected.

TECHNICAL FEATURES

	KT 220	KH 220	KTT 220
Units displayed	°C, °F, °Ctd, °Ftd, %RH, mV, V, mA, A, bar ¹	°C, °F, °Ctd, °Ftd, %RH, lux, fc, mV, V, mA, A, bar ¹	°C, °F
Resolution	0.1°C, 0.1°F, 0.1%RH, 1 mV, 0.001 V, 0.001 mA, 0.1 A, 0.1 bar	0.1°C, 0.1°F, 0.1%RH, 1 lux, 0.1 fc, 1 mV, 0.001 V, 0.001 mA, 0.1 A, 0.1 bar	0.1°C, 0.1°F
External input	Female micro-USB connector		
Input for probe	1 universal input ²	1 universal input ²	2 inputs for thermocouple probes (K, J, T, N, S)
Internal sensor	Temperature	Temperature, humidity, light	Temperature
Type of sensor	NTC	<u>Temperature</u> : NTC <u>Humidity</u> : capacitive <u>Light</u> : photo-diode	Thermocouple
Measuring range	Measuring range of the internal sensor ⁴ : From -40 to +70°C	Measuring range of the internal sensor ⁴ : <u>Temperature</u> : from -20 to +70°C <u>Humidity</u> : from 0 to 100%RH <u>Light</u> : from 0 to +10 000 lux	K: from -200 to +1300°C J: from -100 to +750°C T: from -200 to +400°C N: from -200 to +1300°C S: from 0 to 1760°C
Accuracies³	±0.4°C from -20 to 70°C ±0.8°C below -20°C	<u>Temperature</u> : ±0.4°C from 0 to 50°C ±0.8°C below 0°C or above 50°C <u>Humidity</u> : ±2%RH from 5 to 95%RH from 15°C to 25°C <u>Light</u> : ±10% of reading +10 lux	K, J, T, N: ±0.4°C from 0 to 1300°C ±(0.3% of reading +0.4°C) below 0°C S: ±0.6°C
Setpoints alarm	2 setpoint alarms on each channel		
Frequency of measurement	From 1 second to 24 hours		
Operating temperature*	From -40 to +70°C	From -20 to 70°C	From -20 to 70°C
Storage temperature	From -40 to +85°C		
Battery life	4 years ⁶		
European directives	2011/65/EU RoHS II; 2012/19/EU WEEE; 2014/30/EU EMC; 2014/35/UE		

¹ Some units are available only with optional probes.

² Input which allows to plug different compatible probes: see optional probes and cables page 3.

³ All accuracies indicated in this document were stated in laboratory conditions and can be guaranteed for measurement carried out in the same conditions, or carried out with calibration compensation.

⁴ Other measuring ranges are available according to the connected probe: see optional probes and cables page 3.

⁵ Factory calibration uncertainty: ±0.88 %RH. Temperature dependence: ±0.04 × (T-20) %RH (if T<15°C or T>25°C)

⁶ On the basis of 1 measurement each 15 minutes at 25°C.

*For data loggers with display, the screen can be hard to read, and its display speed often slows down at temperatures lower than 0°C. This has no effect on the accuracy of measurements.

DIMENSIONS (in mm)

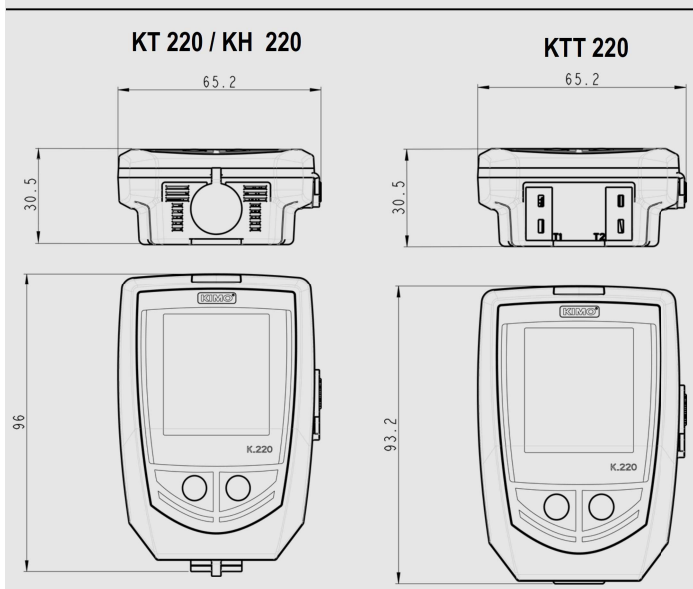

DIMENSIONS OF THE SAFETY LOCK WALL MOUNT (in mm)

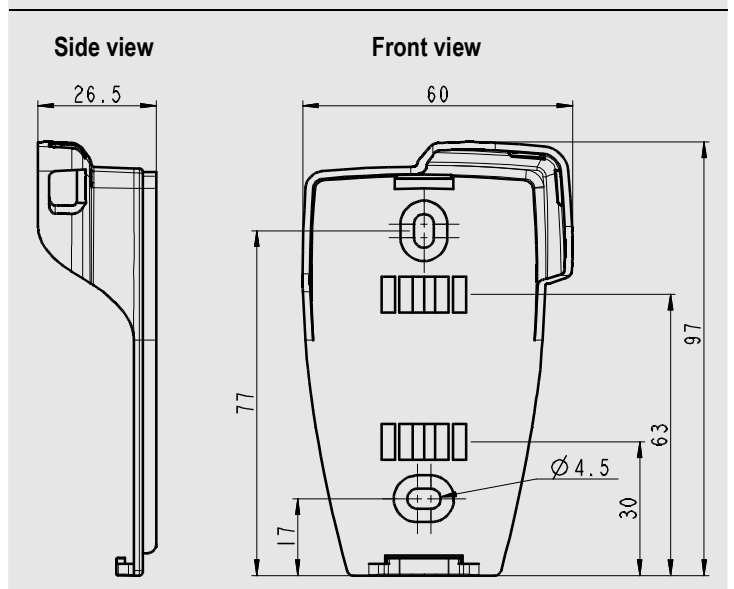

CONNECTIONS

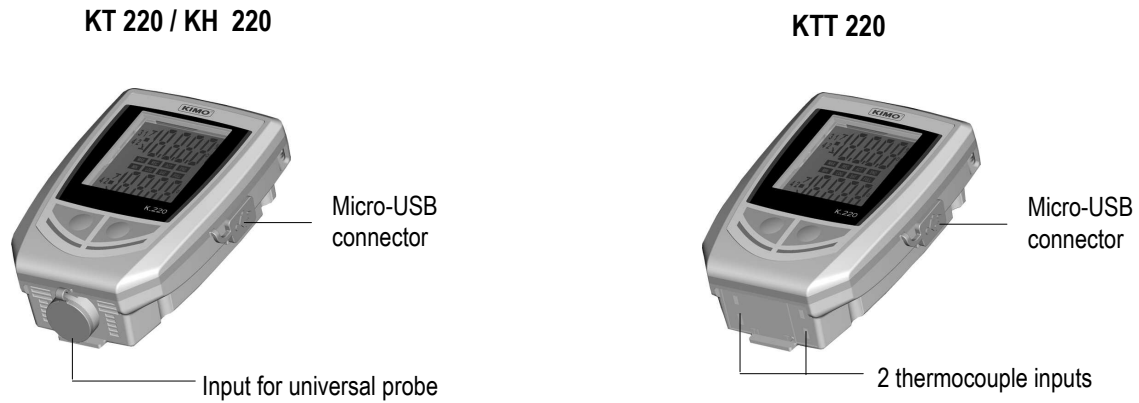

OPTIONAL PROBES AND CABLES¹

Reference	Description	Measuring ranges
<i>Temperature and humidity probe</i>		
KTHA	Interchangeable hygrometry and ambient temperature probe	Hygrometry: from 0 to 100%RH Temperature: from -20 to +70°C
KTHD	Remote interchangeable hygrometry and temperature probe	
<i>NTC Temperature probe</i>		
KSI-50 / KSI-150	IP65 immersion probe	From -40 to +120°C
KSA-150	Ambient use probe	From -40 to +120°C
KSF-2	Wire probe	From -20 to 100°C
KSP-150	IP68 penetration probe	From -40 to +120°C
KSP-150	IP65 penetration probe	From -40 to +120°C
KCV-220	Probe with velcro	From -20 to +90°C
<i>Current and voltage input cables and pulse input cable</i>		
KCTD-10-B	Voltage input cable	0-5 V or 0-10 V
KCCD-02-B	Current input cable	0-20 mA or 4-20 mA
KCTD-I-B	Pulse input cable	Maximal voltage: 5 V Type of input: TTL frequency counting Maximal frequency: 10 kHz Maximum number of recordable points: 20 000 points
<i>Ammeter clamps</i>		
KPID-50-BRF	Ammeter clamp from 0 to 50 A, frequency range from 40 to 5000 Hz	From 0 to 50 A _{AC}
KPID-100-BRF	Ammeter clamp from 0 to 100 A, frequency range from 40 to 5000 Hz	From 1 to 100 A _{AC}
KPID-200-BRF	Ammeter clamp from 0 to 200 A, frequency range from 40 to 5000 Hz	From 1 to 200 A _{AC}
KPID-600-BRF	Ammeter clamp from 0 to 600 A, frequency range from 40 to 5000 Hz	From 1 to 600 A _{AC}
<i>Relative pressure probe (water probe)</i>		
KSPE	Relative pressure probe for liquids and gases (corrosive)	From 0 to 10 bars
KSPE-2	Relative pressure probe for liquids and gases (corrosive)	From 0 to 20 bars
<i>Thermocouple probes</i>		
For more details about the available thermocouple probes, please see the "Thermocouple probes" datasheet.		

5 recording modes

KISTOCK can record in 5 different ways :

- **"Immediate"** mode records values according to a predefined interval.
 - **"Minimum"**, **"Maximum"** and **"Average"** record automatically the calculation of minimum, maximum or average of measured values during an interval of recording.
 - **"Monitoring"** mode allows to get an accurate history report during error events to help troubleshooting, without stopping the measurement logging. To proceed this way, you just have to define :
 - a record interval to be used whilst the readings are beyond the setpoints.
 - a record interval for the values measured during each reading beyond the setpoints.
- Furthermore, you can also let your KISTOCK record non-stop ("**loop**" recording option).

4 types of dataset start

Once your recording mode has been set, you can launch your dataset :

- With a delayed start (with predefined date and time)
- With the software
- With push-button
- With **"Online"** option. In this case, your datasets are directly sent, saved and displayed on your PC in real time.

6 types of dataset stop

You can stop your dataset :

- According to a date and time (if it was started the same way)
- According to a period
- According to a predefined number of recording points
- Once the storage capacity is full
- With **"Stop"** option of the software
- By holding **"OK"** key during 5 seconds, if this function has been previously activated by the software

DISPLAY

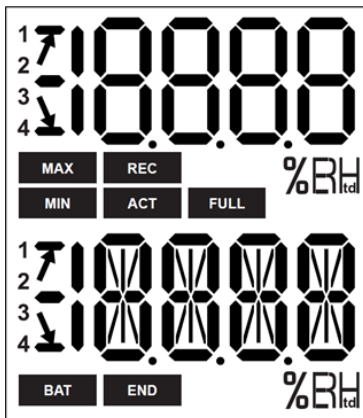

END DATASET is finished.

REC Indicates that one value is being recorded.
It flashes: the DATASET did not start already.

FULL Flashing slowly: DATASET is between 80 and 90 % of the storage capacity.
Flashing quickly: DATASET is between 90 and 100 % of the storage capacity.
Constant: storage capacity full.

BAT Constant: indicates that the batteries have to be replaced.

ACT Screen actualisation of measured values.

MIN
MAX The displayed values are the maximum/minimum values recorded for the channels displayed.

 Indicates the alarm action type: rising or falling action.

1 Indicates the channel number which is
2 measuring.
3
4

 Temperature in °Celsius.

 Temperature in °Fahrenheit .

 Relative humidity (KH 220).

SOFTWARE









- **KILOG LITE:** free software to download on the KIMO website (kimo.fr). Allows the data download (graphics and points statement) and the datalogger configuration.



- **Configuration and data processing software**
KILOG software allows to configure, save and process your data in a very simple way.
- Software only: Ref. *KILOG-3-N*
- Complete set: software + 1 USB cable, Ref. *KIC-3-N*

ACCESSORIES

Accessories	Part numbers	Illustrations
1 AA lithium battery	KBL-AA	
Safety lock wall mount with padlock	KAV-220	
Wired extension for class 220 KISTOCK probes In polyurethane, 5 m length with male and female mini-DIN connectors <i>Note:</i> several extensions can be wired in order to obtain up to 25 m cable length	KRB-220	
Data collector Collects up to 20 000 000 points from one or several KISTOCK directly on-site. Results restitution on PC of realised datasets	KNT-320	
USB micro-USB cable which allows to plug your KISTOCK datalogger to your PC	CK-50	
Neck size hand strap	KDC	



Only the accessories supplied with the device must be used.

CALIBRATION

A calibration certificate is available as option in paper format.
We recommend to carry out a yearly checking.

MAINTENANCE

Please avoid any aggressive solvent.
Please protect the device and probes from any cleaning produce containing formalin, that may be used for cleaning rooms and ducts.

GUARANTEE PERIOD

KISTOCK dataloggers have 1-year guarantee for any manufacturing defect (return to our After-sales service required).

PRECAUTIONS FOR USE

Please always use the device in accordance with its intended use and within parameters described in the technical features in order not to compromise the protection ensured by the device.

MOUNTING

The KT 220, KH 220 and KTT 220 KISTOCK have a magnetic mounting, so you can fix it easily.

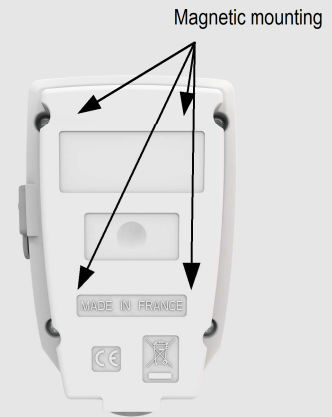

REPLACE THE BATTERY



With 4 years* of battery life, the KISTOCK devices guarantee long-term measurements.

Te replace the battery:

- Unscrew the 4 screws on the back side of the device with a screwdriver.
- Remove the back side and the old batteries.
- Insert the new battery and respect the polarity.
- Replace the back side and the 4 screws.

* On the basis of 1 measurement each 15 minutes at 25°C.



BE CAREFUL! Material damages can happen, so please apply the precautionary measures indicated.



Once returned to KIMO, required waste collection will be assured in the respect of the environment in accordance to guidelines relating to WEEE.

www.kimo.fr

Distributed by :



EXPORT DEPARTMENT
Tel : + 33. 1. 60. 06. 69. 25 - Fax : + 33. 1. 60. 06. 69. 29
e-mail : export@kimo.fr

techniCAL
expanding possibilities
866-327-8731
www.techniCAL-sys.com

