



General features

Power supply	24 Vac / Vdc \pm 10% 100-240 Vac, 50-60 Hz
	Warning: risk of electric shock 
Output	2 x 4-20 mA or 2 x 0-20 mA or 2 x 0-5 V or 2 x 0-10 V (4 wires) Common mode voltage <30 VAC Maximum load: 500 Ohms (0/4-20 mA) Minimum load: 1 K Ohms (0-5/10 V)
Relay outputs	2 changeover relays. NO: 5A / NC: 3A / 240 Vac
Galvanic isolation	Inputs and outputs (models 100-240 Vac) Device fully protected by DOUBLE ISOLATION or REINFORCED ISOLATION  Outputs (models 24 Vac/Vdc)
Consumption	TH210-B: 6 VA / TH210-H: 8 VA
Electrical connection	Screw terminal block for cable 2.5 mm ² Carried out according to the code of good practice
Type of sensor	Hygrometry: capacitive Temperature: Pt100 1/3 as per DIN IEC751
Type of fluid	Air and neutral gases
PC communication	USB-Mini Din cable
Environment	Air and neutral gases
Conditions of use (°C/%RH/m)	From -10 to +50°C. In non-condensing condition. From 0 to 2000 m.
Storage temperature	From -10 to +70°C
Security	Protection class II. Pollution degree 2 Overvoltage category 2 (OVCII)
European directives	2014/30/EU EMC; 2014/35/EU Low Voltage; 2011/65/EU RoHS II; 2012/19/EU WEEE

• Type of caps

Part numbers	EPP2	EPI25	EPI100	EPFI	EPFT	EPH202
Features	Cap: ABS ⁽¹⁾ Filter: meshed, 316 L st. steel 30 mm length	Cap: 316 L stainless steel ⁽²⁾ Filter: meshed, 316 L st. steel 30 mm length	Cap: 316 L stainless steel ⁽²⁾ Filter: meshed, 316 L st. steel 30 mm length	Cap: 316 L stainless steel ⁽²⁾ Filter: sintered, 316 L st. steel 30 mm length	Cap: PTFE ⁽³⁾ Filter: sintered, PTFE 30 mm length	Cap: MnO ₂ ⁽⁴⁾ Filter: sintered, PTFE 33 mm length
Max. particle	25µ	25µ	100µ	25µ	10µ	50µ
Max. air velocity	25 m/s	25 m/s	20 m/s	25 m/s	25 m/s	25 m/s
Max. temperature	80°C	180°C	180°C	180°C	180°C	180°C
Relative humidity	95% RH	95% RH	100% RH	90% RH	90% RH	95% RH
APPLICATIONS						
HVAC air-conditioning system	✓	✓				
Cold storage room			✓		✓	
Industry	✓	✓	✓	✓	✓	
Pharma plants / Microelectronics	✓	✓	✓	✓	✓	✓
Dryer				✓	✓	
Curing				✓		
Swimming-pool			✓			

Features of the housing

Material	ABS V0 as per UL94
Protection	IP65
Display	75 x 40 mm, LCD 20 digits 2 lines. Height of digits: Values: 10 mm; Units: 5 mm
Cable gland	For cables Ø8 mm maximum
Weight	340 g

Dimensions

All dimensions are in millimeters.

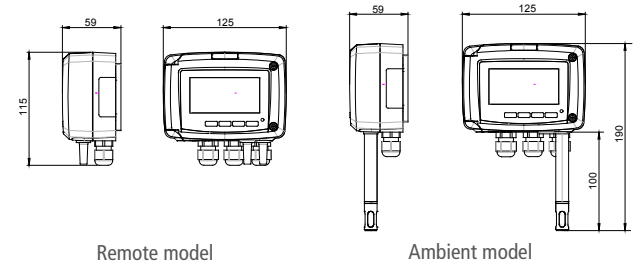

Technical features of probes

• White polycarbonate probe

Measuring range	From -20 to +80°C
Dimensions of standard probe	Ø13 mm, 100 mm length
Dimensions of remote probe	Ø13 mm, 150 or 300 mm length (other length on request)
Cable	Silicone Ø4.8 mm, length 2 m (other length on request)



Polycarbonate probes are supplied with a flow-through ABS protection tip with a stainless steel filter 25 µ (ref: EPP2).

• 316 L stainless steel probe

Measuring range	From -40 to +180°C
Dimensions of remote probe	Ø13 mm, 150 or 300 mm length (other length on request)
Cable	Silicone Ø4.8 mm, length 2 m (other on request)



Stainless steel probes are supplied with a flow through stainless steel protection tip with a stainless steel filter 25 µ (ref: EPI25).

External aggression

Tips protect against the following external aggressions:

- **Water droplets:** EPFT
- **Shaving:** EPI25 et EPFI
- **Duct:** EPFI
- **Chemical product and grease:** EPFT
- **H₂O₂ (hydrogen peroxide):** EPH202

⁽¹⁾ ABS: white acrylonitrile butadiene styrene

⁽²⁾ Stainless steel: 316 L

⁽³⁾ PTFE: white Polytetrafluoroethylene

⁽⁴⁾ MnO₂: manganese dioxide

Connections

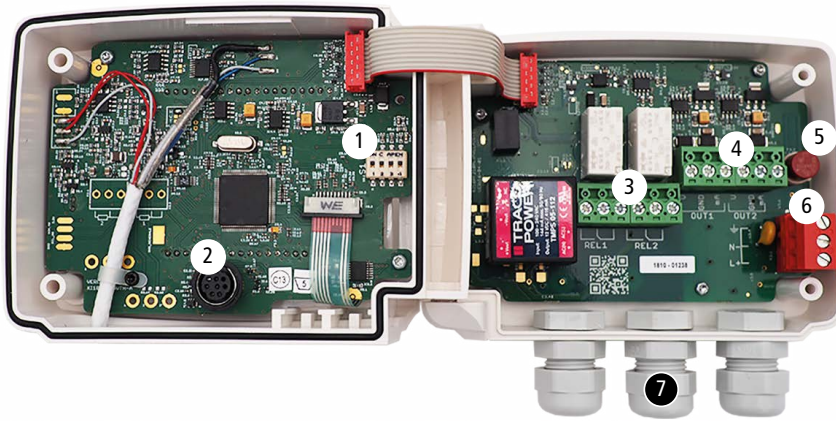

1. DIP switch (d)
2. LCC-S software connections
3. Relays
4. Analogue outputs (a)
5. F3.20* fuse
6. Power supply terminal block (c)
7. Cable glands

Power supply type (b) specified on the label on the side of the transmitter

TH210-HOX-R Power supply: 100-240 Vac 50-60 Hz 8 VA Output: 0/4...20 mA / 0...5/10 V	TH210-HOX-R Power supply: 24 Vac/Vdc ±10 % 50-60 Hz 6 VA Output: 0/4...20 mA / 0...5/10 V
100-240 Vac	24 Vac/Vdc

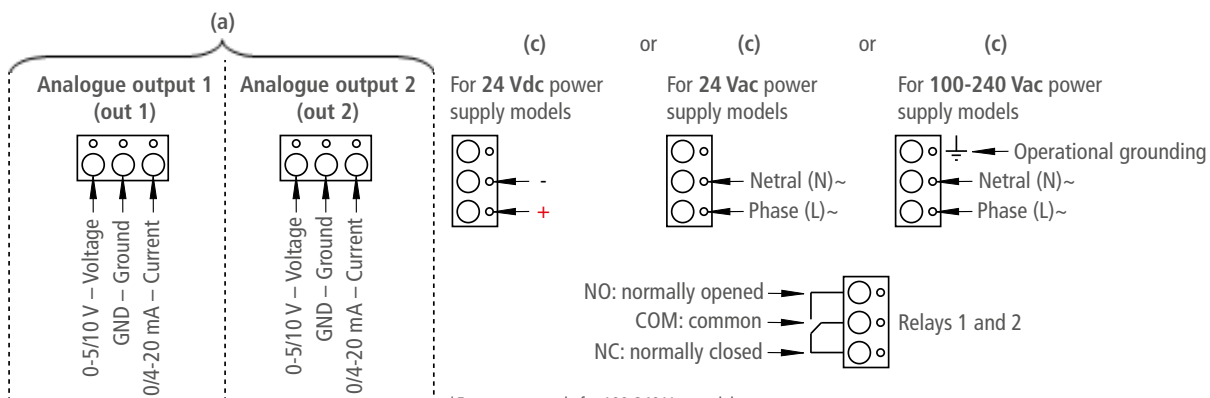

*Fuse present only for 100-240 Vac models.
Every fuse replacement must be performed with a power off device using a TR5 630 mA 250 V fuse.

Electrical connections as per NFC15-100 standard



This connection must be made by a formed and qualified technician. To make the connection, the transmitter must not be energized. Before making the connection, you must first check the power supply indicated on the transmitter board (see (b) in "Connections" part). The presence of a switch and a circuit breaker upstream the device is compulsory

- For transmitters with 24 Vdc power supply:

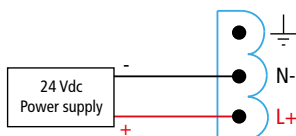

- For transmitters with 24 Vac power supply:

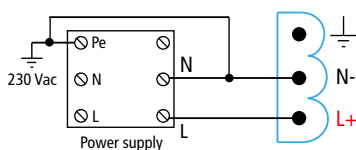
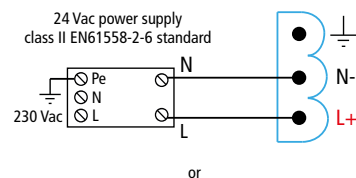

- For transmitters with 100-240 Vac power supply:

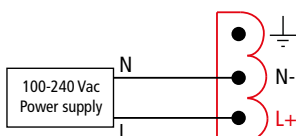

The selection of the output signal in voltage (0-10 V or 0-5 V) or in current (4-20 mA or 0-20 mA) is made via the DIP switch (d) of the electronic board of the transmitter: put the on-of switches as shown in the table below:

Configurations	4-20 mA	0-10 V	0-5 V	0-20 mA
Combinations				

- Connection of the output in current 4-20 mA:
- Connection of output in voltage 0-10 V:

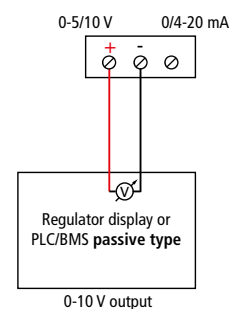
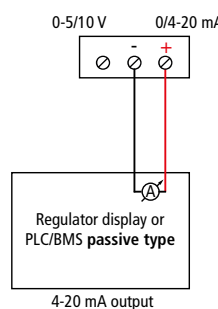

On 100-240 Vac models, if a fuse protection is used for the power line, it is imperative to use delayed-action fuses in order to absorb the surge of current when first turned on the transmitter.

Configuration des capteurs

It is possible on the class 210 to configure all the parameters of the transmitter: units, measuring ranges, outputs, channels, calculation functions, etc. via different methods:

- **Keypad for models with display:** a code-locking system allows to secure the installation (See class 210 transmitters user manual).
- **Software (optional) on all models.** Simple user-friendly configuration. See LCC-S user manual.

Configurable analogue output:

Range with center zero (-40/0/+40°C), with offset zero (-30/0/+70°C) or standard range (0/+100°C). It is possible to configure your own intermediary ranges

Caution: the minimum difference between the high range and the low range is 20.

Configure the range according to your needs: outputs are automatically adjusted to the new measuring range

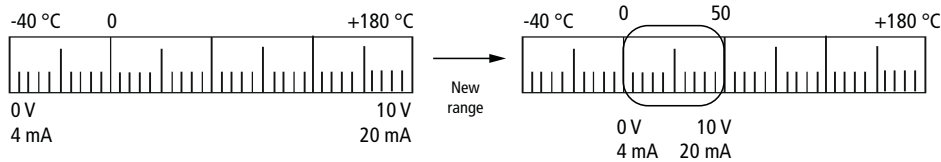

Mounting

To mount the transmitter, mount the ABS plate on the wall (drilling: Ø6 mm, screws and pins are supplied).

Insert the transmitter on the fixing plate (see A on the drawing beside). Rotate the housing in clockwise direction until you hear a "click" which confirms that the transmitter is correctly installed.

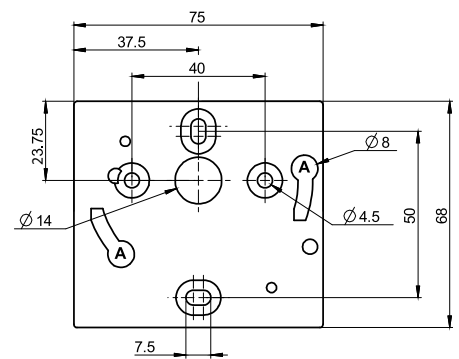

Les dimensions sont exprimées en millimètres.

Maintenance

Please avoid any aggressive solvent. Please protect the transmitter and its probes from any cleaning product containing formalin, that may be used for cleaning rooms or ducts.

Calibration

Outputs diagnostic: With this function, you can check with a multimeter (or on a regulator / display, or a PLC / BMS) if the transmitter outputs work properly. The transmitter generates a voltage of 0 V, 5 V and 10 V or a current of 4 mA, 12 mA and 20 mA

Certificate: Class 210 transmitters are supplied with adjusting certificates. Calibration certificates are available as an option.

Precautions for use

Please always use the device in accordance with its intended use and within parameters described in the technical features in order not to compromise the protection ensured by the device.

Options and accessories

Nom	Référence
Configuration software with USB cable	LCC-S
Calibration certificate	-
Sliding fittings	-
Connection fittings	-
Cable glands	-
Protections tips	-
Wall-mounting support bracket for remote humidity probe	-

techniCAL
Expanding possibilities
866-327-8731
www.techniCAL-sys.com



Only the accessories supplied with the device must be used.